

Blutube Product Catalogue

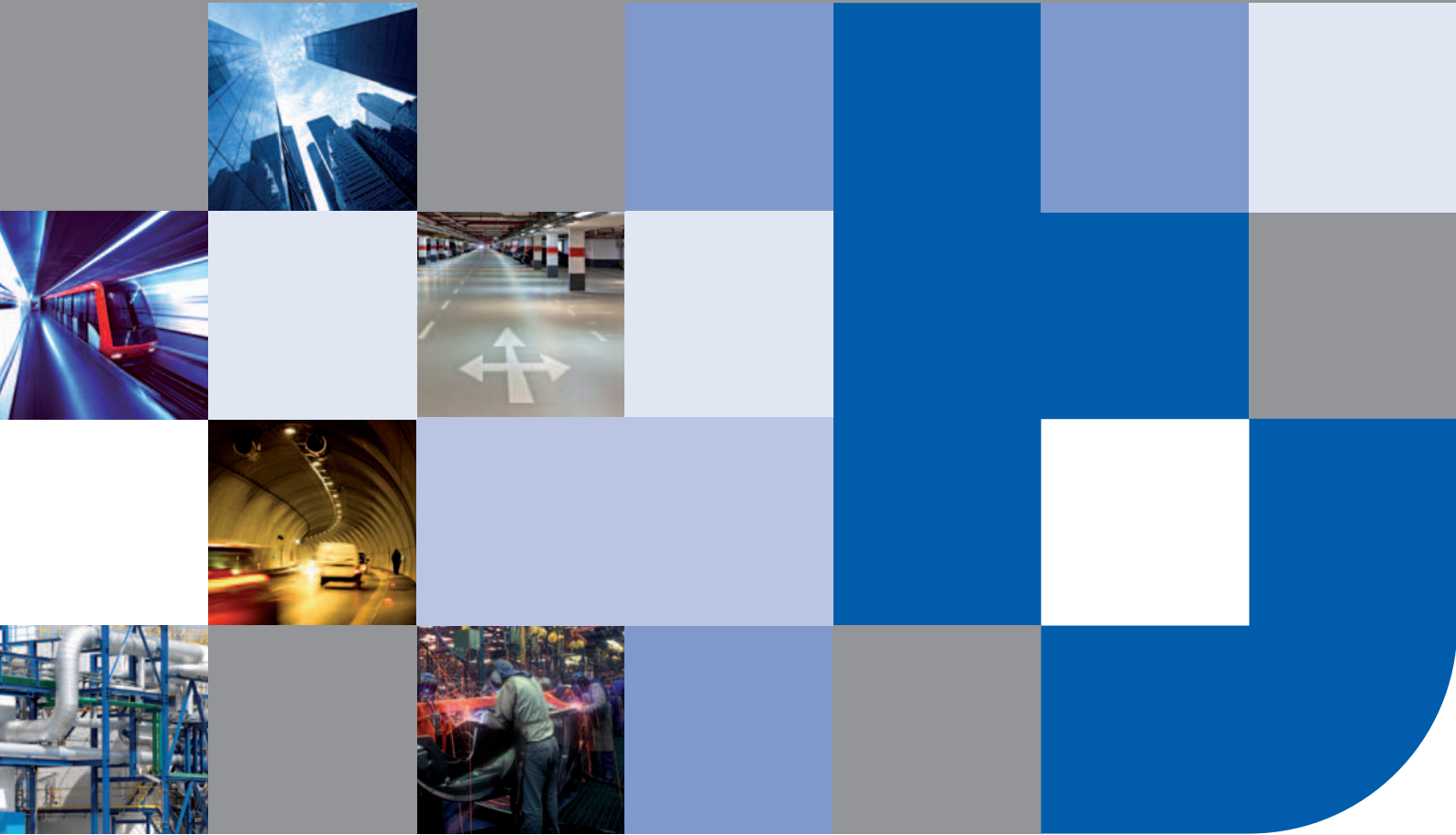



Blutube Compressed Air System	01
Blutube Advantages	02
Blutube Features & Benefits	03
Blutube Component Selection	04
Blutube Air Pipe & Clips	05
Blutube Compression Fittings	06-07
Blutube Socket Fusion Fittings	08-09
Blutube Electro Fusion Fittings	10
Blutube Threaded Fittings	11-12
Blutube Installation Tools	13
Blutube Valves	13
Blutube Support	14-15
Blutube Polyurethane Hose, Reels, Coils & Tube	16
Blutube Accessories	17
Blutube Compressed Air Treatment	18
Blutube Couplings	19
Blutube Design	20
Blutube Installation	21
Blutube Socket & Electro Fusion Welding Instructions	22
Blutube Installation Instructions	23
Compressed Air Flow Charts	4 & 24
Blutube Technical Specifications	25



Blutube

Compressed Air System

Blutube. The instantly recognisable and superior compressed air piping system, Blutube combines the numerous strengths of PE100 polyethylene with the flexibility and choice offered by 3 different connection methods, each offering unsurpassed ease of installation.

The unparalleled design flexibility of Blutube compressed air systems, coupled with quality componentry, offers the highest level of safety making Blutube the system of choice for all Australian industry and specified by leading Mechanical Engineers.

Blutube offers quick installation, strength, safety, reliability and long leevity with no maintenance required.

Quality 50 Year Guarantee

Blutube is made in Australia under strict ISO 9002 Certified Quality Systems and complies with Australian Standards AS4130 & AS4131. Blutube is manufactured from the highest grade of PE in Australian Standard AS4131. Blue colour assists

identification and colour coding without painting. (Australian Standards require marking/colour coding).

WaterMark

Blutube is also suitable for high pressure fluid applications up to PN25 and has WaterMark Certification.



Blutube Advantages

- QUICK & EASY TO INSTALL
- SIMPLE TO ALTER OR ADAPT
- LIGHTWEIGHT
- STRONG & SAFE
- LOW FRICTIONAL LOSSES
- NO RUST
- PIPE SIZES 20MM TO 160MM;
LARGER SIZES AVAILABLE
- FOOD GRADE
- BREATHING AIR APPLICATIONS
- DISTINCTIVE BLUE COLOUR
- EXCELLENT THERMAL PROPERTIES
- UNDERGROUND APPLICATIONS
- UNDERPRESSURE CONNECTION FITTINGS
- 50 YEAR WARRANTY
- AESTHETICALLY PLEASING

Schematic of a Typical Air Line System

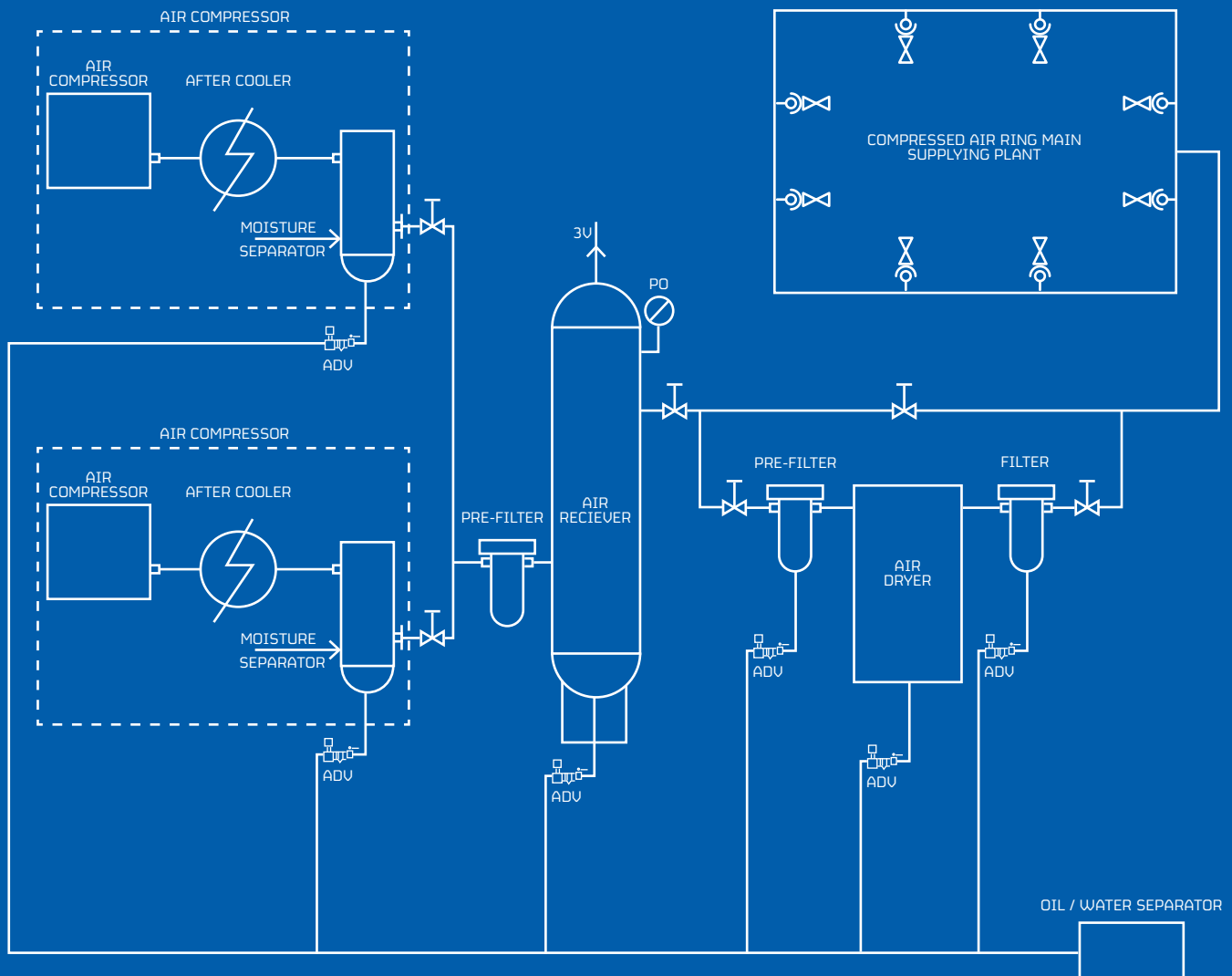

Blutube

Features & Benefits

Fast & Efficient Installation

Blutube can be installed 2-5 times faster than traditional materials and is clean & safe for installers. No threading, flaring, gluing or Oxy/Act welding. Modifications and additional branches, etc are added with a minimum of disruption & cost.

Superior Safety

Blutube is a system of the highest integrity and has an integral Safety Factor of 2:1. Suitable for compressed air pressures up to 16 bar and fluids up to 25 bar as per Australia Standards AS4130, Blutube has higher strength, greater wall thickness, high pressure/ temperature capabilities with minimum 50 year design life. Extremely robust and impact resistant – is not brittle like PVC & PP, (PVC is not safe for compressed air). Excellent for under-ground applications.

Thermally stable and suitable for continuous operation within the temperature range of -20deg C to +60deg C, Blutube can withstand short term rises up to 95deg C.

Corrosion Free

Blutube is corrosion free! Air quality and flow rates are not compromised by age. Traditional galvanised iron air pipe corrodes causing contamination of air supply damaging tools & pneumatics, increased friction resulting in energy losses, reduced bore and eventual need for replacement.

Food Grade & Breathing Air

Blutube is approved for food plants as it does not support bacterial growth or micro-organisms and complies with AS2070.1 "Plastic material for food contact use". Compression fittings conform to

AS4129, BS6920, threaded fittings to AS3855.3 Blutube is also suitable for breathing air systems.

Chemical Resistance

Blutube has extensive chemical resistance/compatibility and provides a solution for corrosive environments. The three fitting ranges available offer various solutions; Compression Fittings come standard with Nitrile O rings and Acetal grip-rings, for some chemical applications Viton and EPDM O rings and CPVC grip-rings can be used. Blutube Socket Fusion provides for a continuous use of identical pipe & fitting material. Please refer to Technical Department for specific applications.

Engineering Design Flexibility

Blutube provides engineers & designers maximum flexibility with Socket Fusion, Electro

Fusion & Compression fitting ranges. This system assists Australian Industry by a total package which is readily altered and changed with minimal "shutdown" time and is ideally suited to today's requirement for quick installation.

BLUTUBE COST SAVINGS

- Economical purchase
- Quick installation
- Longevity with no maintenance required
- Elimination of costly air leaks
- Energy savings through reduced friction
- Ultra smooth bore and no rust/scale build-up
- Savings in modifications, additional branches can be connected while system under pressure



Blutube Component Selection

Pipe Size

When designing your Blutube compressed air system current and future requirements need to be considered for:
-how much air is needed?
-what pressure is required?

-what is the distance from compressor plant to outlets?
-does allowance need to be made for future expansion?
Select an appropriate pipe size from the chart below allowing for the above factors and ensuring distance of flow is included in the calculations.

Pressure/Flow Table

Maximum recommended air flow for each pipe size. The flow values allow for a 4% pressure drop of applied pressure over 30 metres of pipe. If a maximum pressure drop of 2% is desired,

figures listed below should be de-rated by approximately 20%-30%. The table is calculated using values derived from Mueller's formula for gaseous flows.

PRESSURE		BLUTUBE 20		BLUTUBE 25		BLUTUBE 32		BLUTUBE 40		BLUTUBE 50		BLUTUBE 63		BLUTUBE 90		BLUTUBE110		BLUTUBE160	
BAR	PSI	l/sec	cfm	l/sec	cfm	l/sec	cfm	l/sec	cfm	l/sec	cfm	l/sec	cfm	l/sec	cfm	l/sec	cfm	l/sec	cfm
6	87	16	34	32	68	62	132	106	225	195	413	387	820	1054	2233	1732	3671	4872	10323
7	102	19	41	38	81	74	157	127	268	233	494	462	980	1258	2667	2068	4383	5816	12326
7.5	109	21	44	41	87	80	170	137	291	252	534	500	1060	1362	2887	2239	4745	6297	13343
8	116	22	47	44	94	87	184	148	313	272	576	539	1142	1467	3109	2412	5111	6782	14372
10	145	29	61	57	122	112	237	191	405	351	744	697	1476	1896	4019	3117	6606	8766	18576
13	189	39	83	78	164	151	321	258	547	475	1006	942	1996	2564	5434	4215	8933	11853	25118

Conversion Factors

PRESSURE
1 psi = 0.069bar
1 kpa = 0.145psi
1 bar = 100kpa
1 bar = 14.5psi
1 kg/cm² = 1 bar

FLOW
1 cfm = 0.4719 L/sec
1 l/sec = 2.119 cfm
1 m³/min = 16.67 L/sec
1 m³/min = 35.3147 cfm

APPROXIMATE COMPRESSOR OUTPUT CALCULATION:
1kw x 1.35 = HP x 4 =CFM
for Screw compressors.
For Piston compressors some manufacturers quote displacement which needs to be

derated by 0.75 to calculate F.A.D. (Free Air Delivery).
Size of receivers shall be calculated as 10 times the flow in l/s optimum or 6 times the flow in l/s minimum.

Fittings

Select from the three ranges of fittings, note that a combination is often used.

Compression "O" Ring Fittings

Blutube compression fittings are joined by hand and can be removed and reused.



Socket Fusion Weld Fittings

Blutube socket fusion weld fittings are joined using a socket fusion welding tool and results in a fully fused joint of highest integrity.



Electro Fusion Weld Fittings

Blutube electro fusion fittings are assembled by hand and welded via an electro fusion weld machine. These fittings can be assembled and aligned /adjusted prior to welding. They are ideal for large bore pipework being quick and easy



to work with.

This range includes "under-pressure air saddles" which are designed for under pressure connections. They eliminate the need to shut down plant and equipment for new connections and are ideally suited to 24 hour operations.

Outlet Requirements

Select outlets to suit your requirements. This includes filters, regulators, lubricators, quick connection couplings, hoses, etc.



Blutube Air Pipe & Clips

MANUFACTURED TO AS/
NZS4130



PRODUCT CODE	WALL THICKNESS	PN RATING	NOM. I.D Imperial equivalent	O.D.	LENGTH Metres
BLUTUBE 20	2.8mm	PN25	5/8"	20mm	6m
BLUTUBE 25	3.5mm	PN25	3/4"	25mm	6m
BLUTUBE 32	4.4mm	PN25	1"	32mm	6m
BLUTUBE 40	5.5mm	PN25	1 1/4"	40mm	6m
BLUTUBE 50	6.9mm	PN25	1 1/2"	50mm	6m
BLUTUBE 63	8.6mm	PN25	2"	63mm	6m
BLUTUBE 90	12.5mm	PN25	3"	90mm	6m
BLUTUBE 110	15.2mm	PN25	4"	110mm	6m
BLUTUBE 160	22mm	PN25	6"	160mm	6m or 12m

Large Sizes available

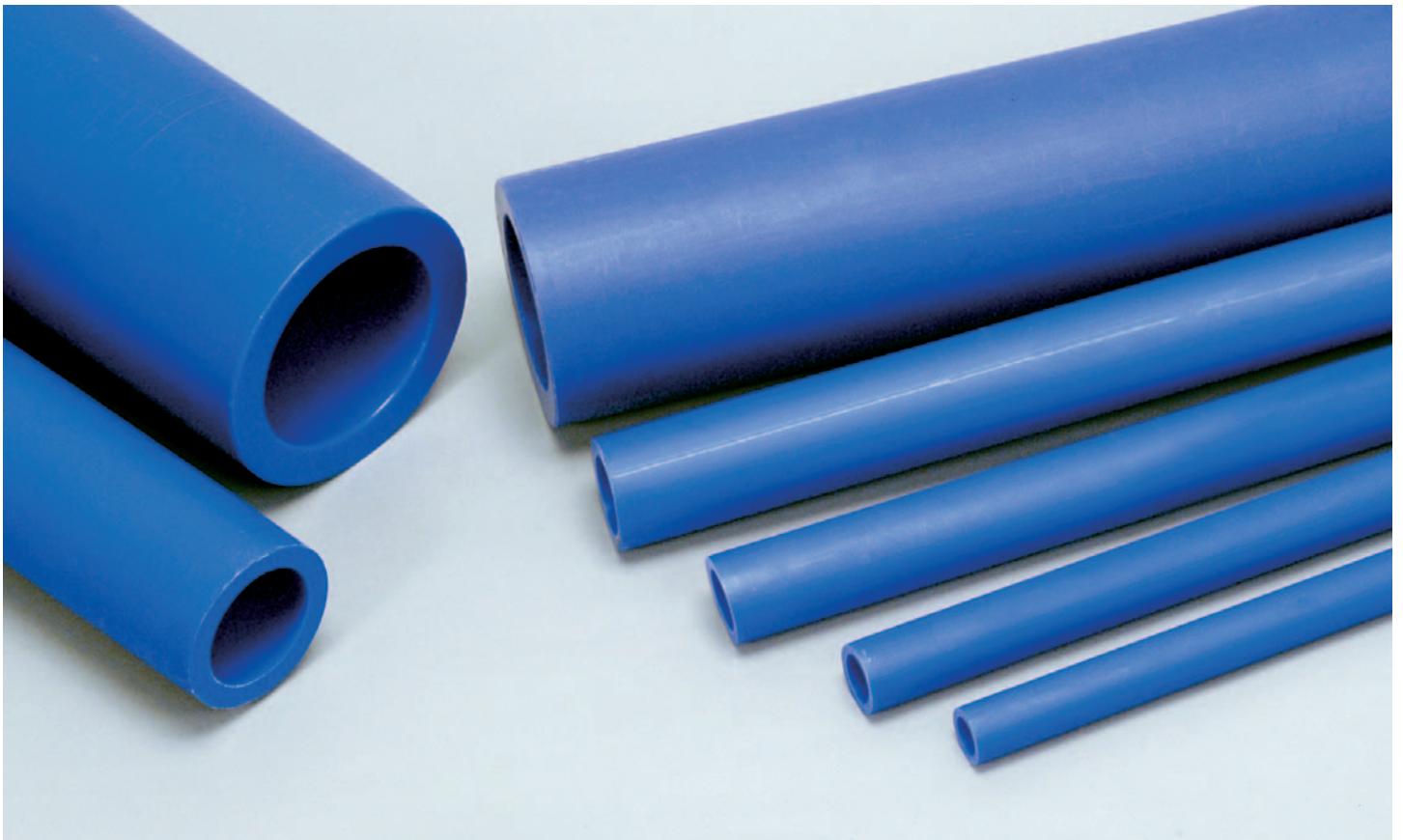

HEAVY DUTY CLIP

SIZE	CODE
63	BHCL 63
90	BHCL 90
110	BHCL 110



BCL PIPE CLIPS

- Multiple fixing points and slots for cable-tie fixings.
- Removable spacer allows 2 set-outs from clip base.
- Adjustable settings allow for movement due to expansion and contraction.

SIZE	CODE
20	BCL20
25	BCL25
32	BCL32
40	BCL40
50	BCL50
63	BCL63
90	BCL90

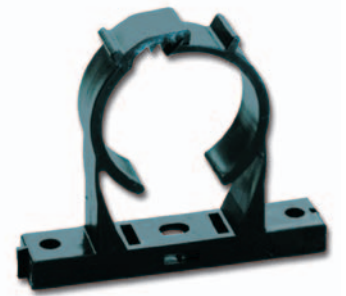

PIPE SUPPORT SYSTEMS P14
AND 15, CLIP SPACING AND
INSTALLATION P23

Blutube Compression Fittings

COUPLING

PIPE x PIPE	CODE
20 x 20	BC 20
25 x 25	BC 25
32 x 32	BC 32
40 x 40	BC 40
50 x 50	BC 50
63 x 63	BC 63
90 x 90	BC 90
110 x 110	BC 110



REDUCING COUPLING

PIPE x PIPE	CODE
25 x 20	BRC 2520
32 x 25	BRC 3225
40 x 32	BRC 4032
50 x 40	BRC 5040
63 x 50	BRC 6350
90 x 63	BRC 9063
110 x 90	BRC 11090



AIR SADDLE

PIPE x FEM THREAD	CODE
32 x 1/2" - 3/4" - 1"	BAS 32*
40 x 1/2" - 3/4" - 1"	BAS 40*
50 x 1/2" - 3/4" - 1"	BAS 50*
63 x 1/2", 3/4", 1", 1 1/4", 1 1/2"	BAS 63*
90 x 1/2" - 3/4", 1", 1 1/4", 1 1/2", 2"	BAS 90*
110 x 1/2" - 3/4", 1", 1 1/4", 1 1/2", 2"	BAS 110*
160 x 1", 1 1/4", 1 1/2", 2"	BAS 160*

(*When ordering please complete code).



FEMALE ADAPTOR

PIPE x THREAD	CODE
20 x 1/2"	BFA 2015
25 x 3/4"	BFA 2520
32 x 3/4"	BFA 3220
32 x 1"	BFA 3225
40 x 1 1/4"	BFA 4032
50 x 1 1/2"	BFA 5040
63 x 2"	BFA 6350



MALE ADAPTOR

PIPE x THREAD	CODE
20 x 1/2"	BMA 2015
25 x 1/2"	BMA 2515
25 x 3/4"	BMA 2520
32 x 3/4"	BMA 3220
32 x 1"	BMA 3225
32 x 1 1/4"	BMA 3232
40 x 1 1/4"	BMA 4032
50 x 1 1/2"	BMA 5040
63 x 2"	BMA 6350
90 x 2"	BMA 9050
90 x 3"	BMA 9080
110 x 2"	BMA 1102
110 x 3"	BMA 1103
110 x 4"	BMA 1104



BLUTUBE TO COPPER PIPE

ADAPTOR SET

COPPER x FITTING	CODE
1/2" x 20	BPCS 2015
3/4" x 25	BPCS 2520
1" x 25	BPCS 2525



END CAPS

PIPE	CODE
20	BEC 20
25	BEC 25
32	BEC 32
40	BEC 40
50	BEC 50
63	BEC 63
90	BEC 90
110	BEC 110

90 DEG TEE

PIPE x PIPE x PIPE	CODE
20 x 20 x 20	BT 20
25 x 25 x 25	BT 25
32 x 32 x 32	BT 32
40 x 40 x 40	BT 40
50 x 50 x 50	BT 50
63 x 63 x 63	BT 63
90 x 90 x 90	BT 90
110 x 110 x 110	BT 110

90 DEG TEE

with threaded Fem Offtake

PIPE x THREAD x PIPE	CODE
20 x 1/2" x 20	BTF 2015
25 x 1/2" x 25	BTF 2515
25 x 3/4" x 25	BTF 2520
32 x 3/4" x 32	BTF 3220
32 x 1" x 32	BTF 3225
40 x 1" x 40	BTF 4025
40 x 1 1/4" x 40	BTF 4032
50 x 1 1/2" x 50	BTF 5040
63 x 2" x 63	BTF 6350

REDUCING 90 DEG TEE

PIPE x PIPE x PIPE	CODE
25 x 20 x 25	BRT 2520
32 x 25 x 32	BRT 3225
40 x 25 x 40	BRT 4025
40 x 32 x 40	BRT 4032
50 x 25 x 50	BRT 5025
50 x 32 x 50	BRT 5032
50 x 40 x 50	BRT 5040
63 x 32 x 63	BRT 6332
63 x 40 x 63	BRT 6340
63 x 50 x 63	BRT 6350

REDUCING SET

FITTING x PIPE	CODE
25 x 20	BRS 2520
32 x 20	BRS 3220
32 x 25	BRS 3225
40 x 32	BRS 4032
50 x 25	BRS 5025
50 x 32	BRS 5032
50 x 40	BRS 5040
63 x 25	BRS 6325
63 x 32	BRS 6332
63 x 40	BRS 6340
63 x 50	BRS 6350



90 DEG ELBOW

PIPE x PIPE	CODE
20 x 20	BE 20
25 x 25	BE 25
32 x 32	BE 32
40 x 40	BE 40
50 x 50	BE 50
63 x 63	BE 63
90 x 90	BE 90
110 x 110	BE 110



90 DEG ELBOW

with threaded Female Offtake

PIPE x THREAD	CODE
20 x 1/2"	BEF 2015
25 x 3/4"	BEF 2520
32 x 3/4"	BEF 3220
32 x 1"	BEF 3225
40 x 1 1/4"	BEF 4032
50 x 1 1/2"	BEF 5040
63 x 2"	BEF 6350



90 DEG ELBOW

with threaded Male Offtake

PIPE x THREAD	CODE
20 x 1/2"	BEM 2015
25 x 1/2"	BEM 2515
25 x 3/4"	BEM 2520
32 x 1"	BEM 3225
40 x 1 1/4"	BEM 4032
50 x 1 1/2"	BEM 5040
63 x 2"	BEM 6350
90 x 3"	BEM 9080
110 x 4"	BEM 1104



ELBOW FEMALE (LUGGED)

PIPE x THREAD	CODE
20 x 1/2"	BLEF 2015
25 x 3/4"	BLEF 2520



COMPRESSION VALVE

PIPE	CODE
20	BCV 20
25	BCV 25
32	BCV 32



UNIVERSAL ADAPTOR

PIPE x METAL PIPE	CODE
25 x 15-22mm	BUA 25A
25 x 20-27mm	BUA 25B
25 x 27-35mm	BUA 25C
32 x 27-35mm	BUA 32
50 x 35-50mm	BUA 50



Blutube

Socket Fusion Fittings

90 DEG TEE

PIPE x PIPE x PIPE	CODE
20 x 20 x 20	BWT 20
25 x 25 x 25	BWT 25
32 x 32 x 32	BWT 32
40 x 40 x 40	BWT 40
50 x 50 x 50	BWT 50
63 x 63 x 63	BWT 63
90 x 90 x 90	BWT 90
110 x 110 x 110	BWT 110

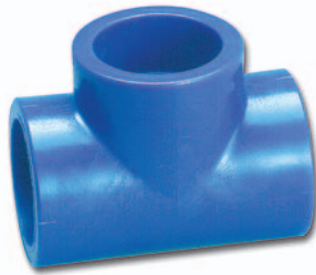

REDUCING 90 DEG TEE

PIPE x PIPE x PIPE	CODE
25 x 20 x 25	BWRT 2520
32 x 20 x 32	BWRT 3220
32 x 25 x 32	BWRT 3225
40 x 20 x 40	BWRT 4020
40 x 25 x 40	BWRT 4025
40 x 32 x 40	BWRT 4032
50 x 20 x 50	BWRT 5020
50 x 25 x 50	BWRT 5025
50 x 32 x 50	BWRT 5032
50 x 40 x 50	BWRT 5040
63 x 25 x 63	BWRT 6325
63 x 32 x 63	BWRT 6332
63 x 40 x 63	BWRT 6340
63 x 50 x 63	BWRT 6350



COUPLINGS

PIPE x PIPE	CODE
20 x 20	BWC 20
25 x 25	BWC 25
32 x 32	BWC 32
40 x 40	BWC 40
50 x 50	BWC 50
63 x 63	BWC 63
90 x 90	BWC 90
110 x 110	BWC 110



REDUCING COUPLINGS

FITTING x PIPE	CODE
25 x 20	BWRC 2520
32 x 20	BWRC 3220
32 x 25	BWRC 3225
40 x 20	BWRC 4020
40 x 25	BWRC 4025
40 x 32	BWRC 4032
50 x 20	BWRC 5020
50 x 25	BWRC 5025
50 x 32	BWRC 5032
50 x 40	BWRC 5040
63 x 25	BWRC 6325
63 x 32	BWRC 6332
63 x 40	BWRC 6340
63 x 50	BWRC 6350
90 x 63	BWRC 9063
110 x 63	BWRC 11063
110 x 90	BWRC 11090



THREADED FLANGE TABLE D

FLANGE x THREAD	CODE
20 x 1/2"	BFT 20
25 x 3/4"	BFT 25
32 x 1"	BFT 32
40 x 1 1/4"	BFT 40
50 x 1 1/2"	BFT 50
63 x 2"	BFT 63
90 x 3"	BFT 90
110 x 4"	BFT 110



STUB FLANGE

PIPE	CODE
20	BWF 20
25	BWF 25
32	BWF 32
40	BWF 40
50	BWF 50
63	BWF 63
90	BWF 90
110	BWF 110

FLANGE KITS TYPE A

PIPE x PIPE	CODE
20 x 20	BFKA 20
25 x 25	BFKA 25
32 x 32	BFKA 32
40 x 40	BFKA 40
50 x 50	BFKA 50
63 x 63	BFKA 63
90 x 90	BFKA 90
110 x 110	BFKA110

CONSISTS OF: 2 x BACKING RING, 2 x STUB FLANGE, 1 x GASKET, BOLTS, WASHERS & NUTS

FLANGE KITS TYPE B

PIPE x THREAD	CODE
20 x 1/2"	BFRB 20
25 x 3/4"	BFRB 25
32 x 1"	BFRB 32
40 x 1 1/4"	BFRB 40
50 x 1 1/2"	BFRB 50
63 x 2"	BFRB 63
90 x 3"	BFRB 90
110 x 4"	BFRB 110

CONSISTS OF: 1 x BACKING RING, 1 x THREADED FLANGE, 1 x STUB FLANGE, 1 x GASKET, BOLTS, WASHERS & NUTS

FLANGE KITS TYPE C TABLE D

PIPE x EXIST FLANGE	CODE
20	BFKC 20
25	BFKC 25
32	BFKC 32
40	BFKC 40
50	BFKC 50
63	BFKC 63
90	BFKC 90
110	BFKC 110

CONSISTS OF: 1 x BACKING RING, 1 x STUB FLANGE, 1 x GASKET, BOLTS, WASHERS & NUTS

BACKING RING

FLANGE	CODE	FLANGE	CODE
20	BBR 20	20	BWFG 20
25	BBR 25	25	BWFG 25
32	BBR 32	32	BWFG 32
40	BBR 40	40	BWFG 40
50	BBR 50	50	BWFG 50
63	BBR 63	63	BWFG 63
90	BBR 90	90	BWFG 90
110	BBR 110	110	BWFG 110

GASKETS

THREADED 90 DEG TEE

PIPE x THREAD	CODE
20 x 1/2"	BWTF 2015
25 x 1/2"	BWTF 2515
32 x 1/2"	BWTF 3215
40 x 1/2"	BWTF 4015



END CAPS

PIPE	CODE
20	BWEC 20
25	BWEC 25
32	BWEC 32
40	BWEC 40
50	BWEC 50
63	BWEC 63
90	BWEC 90
110	BWEC 110

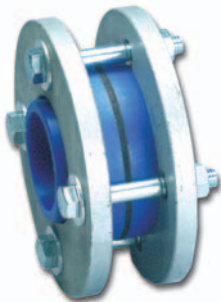

90 DEG ELBOW

PIPE x PIPE	CODE
20 x 20	BWE 20
25 x 25	BWE 25
32 x 32	BWE 32
40 x 40	BWE 40
50 x 50	BWE 50
63 x 63	BWE 63
90 x 90	BWE 90
110 x 110	BWE 110



45 DEG ELBOW

PIPE x PIPE	CODE
20 x 20	BW45 E20
25 x 25	BW45 E25
32 x 32	BW45 E32
40 x 40	BW45 E40
50 x 50	BW45 E50
63 x 63	BW45 E63
90 x 90	BW45 E90
110 x 110	BW45 E110



MALE ADAPTOR

PIPE x THREAD	CODE
20 x 1/2"	BWMA 2015
25 x 3/4"	BWMA 2520
32 x 1"	BWMA 3225
40 x 1 1/4"	BWMA 4032
50 x 1 1/2"	BWMA 5040
63 x 2"	BWMA 6350

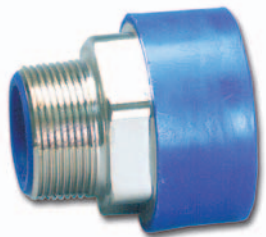

FEMALE ADAPTOR

PIPE x THREAD	CODE
20 x 1/2"	BWFA 2015
25 x 3/4"	BWFA 2520
32 x 1"	BWFA 3225
40 x 1 1/4"	BWFA 4032
50 x 1 1/2"	BWFA 5040
63 x 2"	BWFA 6350



THREADED 90 DEGREE ELBOWS

PIPE x THREAD	CODE
20 x 1/2"	BWEF 2015 Lugged (Right)
25 x 3/4"	BWEF 2520 No lug (Left)



Blutube

Electro Fusion Fittings

JOINER

PIPE x PIPE	CODE
20 x 20	BEFC 20
25 x 25	BEFC 25
32 x 32	BEFC 32
40 x 40	BEFC 40
50 x 50	BEFC 50
63 x 63	BEFC 63
90 x 90	BEFC 90
110 x 110	BEFC 110
160 x 160	BEFC 160



REDUCING JOINER

PIPE x PIPE	CODE
25 x 20	BEFRC 2520
32 x 25	BEFRC 3225
40 x 32	BEFRC 4032
50 x 40	BEFRC 5040
63 x 32	BEFRC 6332
63 x 40	BEFRC 6340
63 x 50	BEFRC 6350
90 x 63	BEFRC 9063
110 x 63	BEFRC 11063
110 x 90	BEFRC 11090
160 x 90	BEFRC 16090
160 x 110	BEFRC 160110



TEE

PIPE x FITTING	CODE
20 x 20	BEFT 20
25 x 25	BEFT 25
32 x 32	BEFT 32
40 x 40	BEFT 40
50 x 50	BEFT 50
63 x 63	BEFT 63
90 x 90	BEFT 90
110 x 110	BEFT 110
160 x 160	BEFT 160



REDUCING TEE

PIPE x FITTING	CODE
25 x 20	BEFRT 2520
32 x 25	BEFRT 3225
40 x 32	BEFRT 4032
50 x 40	BEFRT 5040
63 x 32	BEFRT 6332
63 x 40	BEFRT 6340
63 x 50	BEFRT 6350
90 x 63	BEFRT 9063
110 x 63	BEFRT 11063
110 x 90	BEFRT 11090
160 x 90	BEFRT 16090
160 x 110	BEFRT 160110



REDUCING SPIGOT

FITTING x FITTING	CODE
32 x 25	BEFRS 3225
40 x 32	BEFRS 4032
50 x 40	BEFRS 5040
63 x 50	BEFRS 6350
90 x 63	BEFRS 9063
110 x 63	BEFRS 11063
110 x 90	BEFRS 11090
160 x 90	BEFRS 16090
160 x 110	BEFRS 160110



MALE ADAPTOR

PIPE x THREAD	CODE
20 x 1/2"	BEFMA 2015
25 x 3/4"	BEFMA 2520
32 x 1"	BEFMA 3225
40 x 1 1/4"	BEFMA 4032
50 x 1 1/2"	BEFMA 5040
63 x 2"	BEFMA 6350



FEMALE ADAPTOR

PIPE x THREAD	CODE
20 x 1/2"	BEFFA 2015
25 x 3/4"	BEFFA 2520
32 x 1"	BEFFA 3225
40 x 1 1/4"	BEFFA 4032
50 x 1 1/2"	BEFFA 5040
63 x 2"	BEFFA 6350



THREADED FLANGE

TABLE D

PIPE x FLANGE	CODE
20 x 1/2"	BFT 20
25 x 3/4"	BFT 25
32 x 1"	BFT 32
40 x 1 1/4"	BFT 40
50 x 1 1/2"	BFT 50
63 x 2"	BFT 63
90 x 3"	BFT 90
110 x 4"	BFT 110
160 x 6"	BFT 160



END PLUG

FITTING	CODE
20	BEFEC 20
25	BEFEC 25
32	BEFEC 32
40	BEFEC40
50	BEFEC 50
63	BEFEC 63
90	BEFEC 90
110	BEFEC 110
160	BEFEC 160



90 DEG ELBOW

PIPE x PIPE	CODE
20 x 20	BEFE 20
25 x 25	BEFE 25
32 x 32	BEFE 32
40 x 40	BEFE 40
50 x 50	BEFE 50
63 x 63	BEFE 63
90 x 90	BEFE 90
110 x 110	BEFE 110
160 x 160	BEFE 160



45 DEG ELBOW

PIPE x PIPE	CODE
20 x 20	BEF45E 20
25 x 25	BEF45E 25
32 x 32	BEF45E 32
40 x 40	BEF45E 40
50 x 50	BEF45E 50
63 x 63	BEF45E 63
90 x 90	BEF45E 90
110 x 110	BEF45E 110
160 x 160	BEF45E 160



STUB FLANGE

FITTING x FLANGE	CODE
20 x 20	BEFF 20
25 x 25	BEFF 25
32 x 32	BEFF 32
40 x 40	BEFF 40
50 x 50	BEFF 50
63 x 63	BEFF 63
90 x 90	BEFF 90
110 x 110	BEFF 110
160 x 160	BEFF 160



AIR SADDLE

for under pressure connections

PIPE x FITTING	CODE
40 x 32	BEFASP 4032
50 x 25	BEFASP 5025
50 x 32	BEFASP 5032
63 x 32	BEFASP 6332
63 x 40	BEFASP 6340
63 x 50	BEFASP 6350
90 x 32	BEFASP 9032
90 x 40	BEFASP 9040
90 x 50	BEFASP 9050
90 x 63	BEFASP 9063
110 x 32	BEFASP 11032
110 x 40	BEFASP 11040
110 x 50	BEFASP 11050
110 x 63	BEFASP 11063
160 x 32	BEFASP 16032
160 x 40	BEFASP 16040
160 x 50	BEFASP 16050
160 x 63	BEFASP 16063



BRANCH SADDLE

PIPE x FITTING	CODE
90 x 32	BEFBS 9032
90 x 40	BEFBS 9040
90 x 50	BEFBS 9050
90 x 63	BEFBS 9063
110 x 32	BEFBS 11032
110 x 40	BEFBS 11040
110 x 50	BEFBS 11050
110 x 63	BEFBS 11063
160 x 32	BEFBS 16032
160 x 40	BEFBS 16040
160 x 50	BEFBS 16050
160 x 63	BEFBS 16063



BACKING RING

TABLE D

PIPE x FLANGE	CODE
20 x 20	BBR 20
25 x 25	BBR 25
32 x 32	BBR 32
40 x 40	BBR 40
50 x 50	BBR 50
63 x 63	BBR 63
90 x 90	BBR 90
110 x 110	BBR 110
160 x 160	BBR 160

Left in Photo.

GASKET

FLANGE	CODE
20	BWFG 20
25	BWFG 25
32	BWFG 32
40	BWFG 40
50	BWFG 50
63	BWFG 63
90	BWFG 90
110	BWFG 110
160	BWFG 160

Right in Photo.



PIPE WIPES

FOR PRE-CLEANING OF WELD SURFACES.

BEFPW QTY 50 PER CONTAINER





Blutube Threaded Fittings

Heavy duty threaded fittings made from brass and highest quality engineering grade nylon.
Maximum nylon temperature range with load 100 Deg C. Nylon pressure ratings @ 20 Deg C. Up to 50mm 16 bar / 235psi
65mm 12 bar /175psi
80 and 100mm 10 bar /145 psi

REDUCING HEX BUSH

SIZE	NYLON CODE	BRASS CODE
1/4" x 1/8"		BBRB 0806
3/8" x 1/4"		BBRB 1008
1/2" x 1/4"	BPRB 1508	BBRB 1508
1/2" x 3/8"	BPRB 1510	BBRB 1510
3/4" x 1/4"	BPRB 2008	BBRB 2008
3/4" x 3/8"	BPRB 2010	BBRB 2010
3/4" x 1/2"	BPRB 2015	BBRB 2015
1" x 1/2"	BPRB 2515	BBRB 2515
1" x 3/4"	BPRB 2520	BBRB 2520
1 1/4" x 1/2"		BBRB 3215
1 1/4" x 3/4"	BPRB 3220	BBRB 3220
1 1/4" x 1"	BPRB 3225	BBRB 3225
1 1/2" x 1/2"		BBRB 4015
1 1/2" x 3/4"	BPRB 4020	BBRB 4020
1 1/2" x 1"	BPRB 4025	BBRB 4025
1 1/2" x 1 1/4"	BPRB 4032	BBRB 4032
2" x 3/4"	BPRB 5020	BBRB 5020
2" x 1"	BPRB 5025	BBRB 5025
2" x 1 1/4"	BPRB 5032	BBRB 5032
2" x 1 1/2"	BPRB 5040	BBRB 5040
2 1/2" x 2"	BPRB 6550	BBRB 6550
3" x 1 1/2"	BPRB 8040	
3" x 2"	BPRB 8050	BBRB 8050
3" x 2 1/2"	BPRB 8065	BBRB 8065
4" x 2"	BPRB 10050	BBRB 10050
4" x 2 1/2"	BPRB 10065	BBRB 10065
4" x 3"	BPRB 10080	BBRB 10080



ELBOW M & F

SIZE	NYLON CODE	BRASS CODE
1/4"		BBMFE 08
3/8"		BBMFE 10
1/2"	BPMFE 15	BBMFE 15
3/4"	BPMFE 20	BBMFE 20
1"	BPMFE 25	BBMFE 25
1 1/4"	BPMFE 32	BBMFE 32
1 1/2"	BPMFE 40	BBMFE 40
2"	BPMFE 50	BBMFE 50

ELBOW F & F

SIZE	NYLON CODE	BRASS CODE
1/4"		BBE 08
3/8"		BBE 10
1/2"	BPE 15	BBE 15
3/4"	BPE 20	BBE 20
1"	BPE 25	BBE 25
1 1/4"	BPE 32	BBE 32
1 1/2"	BPE 40	BBE 40
2"	BPE 50	BBE 50
2 1/2"	BPE 65	BBE 65
3"	BPE 80	BBE 80
4"	BPE 100	BBE 100



HEX NIPPLE

SIZE	NYLON CODE	BRASS CODE
1/8"		BBHN 06
1/4"	BPHN 08	BBHN 08
3/8"	BPHN 10	BBHN 10
1/2"	BPHN 15	BBHN 15
3/4"	BPHN 20	BBHN 20
1"	BPHN 25	BBHN 25
1 1/4"	BPHN 32	BBHN 32
1 1/2"	BPHN 40	BBHN 40
2"	BPHN 50	BBHN 50
2 1/2"	BPHN 65	BBHN 65
3"	BPHN 80	BBHN 80
4"	BPHN 100	BBHN 100

REDUCING HEX NIPPLE

SIZE	NYLON CODE	BRASS CODE
1/4" x 1/8"		BBRHN 0806
3/8" x 1/4"		BBRHN 1008
1/2" x 1/8"	BPRHN 1506	BBRHN 1506
1/2" x 1/4"	BPRHN 1508	BBRHN 1508
1/2" x 3/8"	BPRHN 1510	BBRHN 1510
3/4" x 1/4"		BBRHN 2008
3/4" x 3/8"	BPRHN 2010	BBRHN 2010
3/4" x 1/2"	BPRHN 2015	BBRHN 2015
1" x 1/2"	BPRHN 2515	BBRHN 2515
1" x 3/4"	BPRHN 2520	BBRHN 2520
1 1/4" x 1/2"		BBRHN 3215
1 1/4" x 3/4"	BPRHN 3220	BBRHN 3220
1 1/4" x 1"	BPRHN 3225	BBRHN 3225
1 1/2" x 3/4"	BPRHN 4020	BBRHN 4020
1 1/2" x 1"	BPRHN 4025	BBRHN 4025
1 1/2" x 1 1/4"	BPRHN 4032	BBRHN 4032
2" x 3/4"	BPRHN 5020	
2" x 1"	BPRHN 5025	BBRHN 5025
2" x 1 1/4"	BPRHN 5032	BBRHN 5032
2" x 1 1/2"	BPRHN 5040	BBRHN 5040
2 1/2" x 2"	BPRHN 6550	BBRHN 6550
3" x 1 1/2"	BPRHN 8040	
3" x 2"	BPRHN 8050	BBRHN 8050
3" x 2 1/2"	BPRHN 8065	BBRHN 8065
4" x 2"	BPRHN 10050	BBRHN 10050
4" x 2 1/2"	BPRHN 10065	BBRHN 10065
4" x 3"	BPRHN 10080	BBRHN 10080



TEE

SIZE	NYLON CODE	BRASS CODE
1/4"		BBT 08
3/8"		BBT 10
1/2"	BPT 15	BBT 15
3/4"	BPT 20	BBT 20
1"	BPT 25	BBT 25
1 1/4"	BPT 32	BBT 32
1 1/2"	BPT 40	BBT 40
2"	BPT 50	BBT 50
2 1/2"	BPT 65	BBT 65
3"	BPT 80	BBT 80
4"	BPT 100	BBT 100

SOCKET

SIZE	NYLON CODE	BRASS CODE
1/8"		BBS 06
1/4"		BBS 08
3/8"		BBS 10
1/2"	BPS 15	BBS 15
3/4"	BPS 20	BBS 20
1"	BPS 25	BBS 25
1 1/4"	BPS 32	BBS 32
1 1/2"	BPS 40	BBS 40
2"	BPS 50	BBS 50
2 1/2"	BPS 65	BBS 65
3"	BPS 80	BBS 80
4"	BPS 100	BBS 100



PLUG

SIZE	NYLON CODE	BRASS CODE
1/8"		BBP 06
1/4"		BBP 08
3/8"		BBP 10
1/2"	BPP 15	BBP 15
3/4"	BPP 20	BBP 20
1"	BPP 25	BBP 25
1 1/4"	BPP 32	BBP 32
1 1/2"	BPP 40	BBP 40
2"	BPP 50	BBP 50
2 1/2"	BPP 65	BBP 65
3"	BPP 80	BBP 80
4"	BPP 100	BBP 100



Fittings also available in Stainless Steel

DOUBLE OUTLET - BRASS MALE INLET

SIZE	CODE
1/4" x 1/4"	BBDOMF 08
3/8" x 3/8"	BBDOMF 10
1/2" x 1/2"	BBDOMF 15



DOUBLE OUTLET - BRASS FEMALE INLET

SIZE	CODE
1/4" x 1/4"	BBDO 08
3/8" x 3/8"	BBDO 10
1/2" x 1/2"	BBDO 15



BRASS LUGGED ELBOW

SIZE	CODE
1/2"	BBLE 15



TRIPLE OUTLET - ALLOY MALE x FEMALE

SIZE x LENGTH	CODE
1/2" x 1/4" F x 3	BATO 1508
3/4" x 1/4" F x 3	BATO 2008



MANIFOLDS

INLET	OUTLET	CODE
With fixing holes		
2 x 1/2"	2 x 1/4"	BLA2
2 x 1/2"	3 x 1/4"	BLA3
2 x 1/2"	4 x 1/4"	BLA4
2 x 1/2"	5 x 1/4"	BLA5
1/4"	5 x 1/4"	BAN5



BRASS ALLTHREAD

SIZE x LENGTH	CODE
1/2" x 300	BBAT15
3/4" x 300	BBAT20
1" x 300	BBAT25
1-1/4" x 300	BBAT32
1-1/2" x 300	BBAT40
2" x 300	BBAT50



BRASS BARREL UNIONS M&F

SIZE	CODE
1/2"	BBBU 15
3/4"	BBBU 20
1"	BBBU 25
1 1/4"	BBBU 32
1 1/2"	BBBU 40
2"	BBBU 50

F & F also available



LINE STRAINER

SIZE	CODE
1/2"	BLS 15
3/4"	BLS 20



PORTING BLOCK

SIZE	CODE
1/4"	BPB 08
3/8"	BPB 10
1/2"	BPB 15



HOSE BARBS - BRASS

HOSE SIZE x THREAD	CODE
1/4" x 1/4"	BBHB 0808
3/8" x 1/4"	BBHB 1008
1/2" x 1/4"	BBHB 1208
1/4" x 3/8"	BBHB 0810
3/8" x 3/8"	BBHB 1010
1/2" x 3/8"	BBHB 1210
3/8" x 1/2"	BBHB 1015
1/2" x 1/2"	BBHB 1215
3/4" x 1/2"	BBHB 2015
1/2" x 3/4"	BBHB 1220
3/4" x 3/4"	BBHB 2020
1" x 3/4"	BBHB 2520
3/4" x 1"	BBHB 2025
1" x 1"	BBHB 2525



FEM HOSE BARBS - BRASS

HOSE x THREAD	CODE
3/8" x 1/4"	BFBHB 1008
1/2" x 1/4"	BFBHB 1208



BARBED TEE - BRASS

HOSE SIZE	CODE
3/8" x 3/8"	BBHT 10
1/2" x 1/2"	BBHT 12



BARBED HOSE JOINER-BRASS

HOSE SIZE	CODE
3/8" x 3/8"	BBHJ 10
1/2" x 1/2"	BBHJ 12



PRESSURE SAFETY VALVE

SIZE	CODE
1/4"	BPSV 08
1/2"	BPSV 15
3/4"	BPSV 20
1"	BPSV 25

(Refer to technical department for recommended ratings).



NON-RETURN VALVE

SIZE	CODE
1/4"	BNRV 08
1/2"	BNRV 15
3/4"	BNRV 20
1"	BNRV 25
1 1/4"	BNRV 32
1 1/2"	BNRV 40
2"	BNRV 50



ZIP SWIVEL

SIZE	CODE
1/4" M & F	BZS 08

All direction swivelling hose connector for air tools. Reduces operator fatigue. Increases hose life.



PRESSURE GAUGE

SIZE	CODE
40	BPG 40
50	BPG 50
63	BPG 63
80	BPG 80
100	BPG 100





Blutube Installation Tools

PIPE CUTTERS

FOR PIPE SIZES	CODE
20-40mm	BPC40
20-63mm	BPC63



NUT WRENCH

FITTING	CODE
20 - 40mm	BNW
40 - 63mm	BNW1
63 - 110mm	BNW2



PIPE CHAMFERING TOOLS

FOR PIPE SIZES	CODE
20 - 63mm (left)	BCHAM 2063
20 - 63mm (right)	BCHAM 2063P



ELECTRO FUSION WELDER

PIPE	CODE
20-110mm	BEF WELDER



SOCKET FUSION WELDING MACHINE

STYLE	CODE
Hand machine 20-63mm	BSFHM
Bench machine 20-90mm	BSFBM



PIPE SCRAPERS FOR FUSION WELD PROCESS

PIPE	CODE
20mm	BWPS 20
25mm	BWPS 25
32mm	BWPS 32
40mm	BWPS 40
50mm	BWPS 50
63mm	BWPS 63

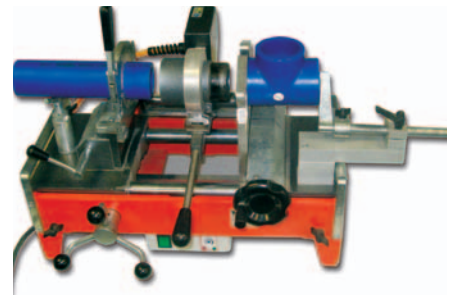

WELDED PIPE SCRAPER

SIZE	CODE
63-160mm	BWPS 16063



Blutube Valves

BALL VALVES FEM & FEM

SIZE	CODE
1/4"	BMV08
1/2"	BBV15
3/4"	BBV20
1"	BBV25
1 1/4"	BBV32
1 1/2"	BBV40
2"	BBV50
3"	BBV80
4"	BBV100



BALL VALVES MALE & FEM

SIZE	CODE
1/4"	BMVMF08
1/4"	BBVMF08
1/2"	BBVMF15



BUTTERFLY VALVES

TYPE	CODE
50mm WAFER	BBVFW50
50mm LUGGED	BBVFL50
80mm WAFER	BBVFW80
80mm LUGGED	BBVFL80
100mm WAFER	BBVFW100
100mm LUGGED	BBVFL100
150mm WAFER	BBVFW150
150mm LUGGED	BBVFL150



LUGGED

WAFER

Lugged Valves are Table D
50mm, 80mm & 100mm
M16 threads
150mm M20 threads

Blutube Support

PURLIN HANGER

CODE	DESCRIPTION
BHS 1A	Used to mount BCL pipe clips

BEAM CLAMPS

CODE	DESCRIPTION
BHS 2U	FOR UP TO 16mm BEAMS (above) (For hanging 10mm threaded rod, mounting BCL pipe clips etc)
BHS 2A	FOR 3mm-7mm BEAMS
BHS 2B	FOR 8mm-13mm BEAMS
BHS 2C	FOR 14mm-20mm BEAMS (below) (For mounting BCL pipe clips/cable ties etc)

HEAVY DUTY BEAM CLAMPS

CODE	DESCRIPTION
BHS 2U HD	For beams up to 20mm

BEAM CLAMP PIPE HANGER

CODE	DESCRIPTION
BHS 2A H1	FOR PIPE UP TO 32mm
BHS 2B H1	FOR PIPE UP TO 32mm
BHS 2C H1	FOR PIPE UP TO 32mm
BHS 2A H2	FOR PIPE UP TO 50mm
BHS 2B H2	FOR PIPE UP TO 50mm
BHS 2C H2	FOR PIPE UP TO 50mm

BEAM STRAP CLAMP

CODE	DESCRIPTION
BHS 2A ST3	RETAINS PIPE IN CRANE BEAMS ETC
BHS 2B ST3	RETAINS PIPE IN CRANE BEAMS ETC
BHS 2C ST3	RETAINS PIPE IN CRANE BEAMS ETC

3=75mm strap, 150mm is available

ROD CLAMP PIPE HANGER

CODE	DESCRIPTION
	5mm ROD PIPE HANGER FOR PIPE For use above suspended ceilings
BHS5 H1	UP TO 32mm
BHS5 H2	UP TO 50mm

PURLIN HANGER FOR PIPE

CODE	DESCRIPTION
BHS 1A H1	FOR PIPE UP TO 32mm
BHS 1A H2	FOR PIPE UP TO 50mm

Left in Photo.

HANGING CLIPS

CODE	DESCRIPTION
BH1	FOR PIPE UP TO 32mm
BH2	FOR PIPE UP TO 50mm

Right in Photo.

GIRT BLOCK

CODE	DESCRIPTION
BHSGB	PLACE IN GIRTS FOR PIPE SUPPORT

CHANNEL

CODE	DESCRIPTION
BHS7	CHANNEL FOR PIPE SUPPORTS (REQ. 3 HANGERS PER 6M LENGTH)

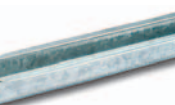

CHANNEL JOINER

CODE	DESCRIPTION
BHS7A	CHANNEL JOINER

MOUNTING PLATES

CODE	DESCRIPTION
BHSCMP10	SUITS M10 ROD
BHSCMP12	SUITS M12 ROD

ROD PURLIN HANGER (SUITS THREADED ROD)

CODE	DESCRIPTION
BHSP 10	LIGHT DUTY SUITS M10 ROD
BHSPH 10	HEAVY DUTY SUITS M10 ROD
BHSPH 12	HEAVY DUTY SUITS M12 ROD

THREADED ROD

CODE	DESCRIPTION
BHS ROD10	10mm 3 metre length
BHS ROD12	12mm 3 metre length

THREADED ROD NUT

CODE	DESCRIPTION
BHSN10	10mm NUT
BHSN12	12mm NUT

BOLTED PIPE CLIP TO SUIT ROD

CODE	DESCRIPTION
BHSBC 20M10	SUIT 20mm PIPE & 10mm ROD
BHSBC 25M10	SUIT 25mm PIPE & 10mm ROD
BHSBC 32M10	SUIT 32mm PIPE & 10mm ROD
BHSBC 40M10	SUIT 40mm PIPE & 10mm ROD
BHSBC 50M10	SUIT 50mm PIPE & 10mm ROD
BHSBC 63M10	SUIT 63mm PIPE & 10mm ROD
BHSBC 90M10	SUIT 90mm PIPE & 10mm ROD
BHSBC 110M10	SUIT 110mm PIPE & 10mm ROD
BHSBC 90M12	SUIT 90mm PIPE & 12mm ROD
BHSBC 110M12	SUIT 110mm PIPE & 12mm ROD
BHSBC 160M12	SUIT 160mm PIPE & 12mm ROD

HEAVY DUTY STRUT SYSTEM 6m length

CODE	DESCRIPTION
BHS STRUT 20	21 x 41 x 1.6
BHS STRUT 40	41 x 41 x 1.6

HEAVY DUTY STRUT BRACKETS

CODE	DESCRIPTION
BHS STRUT J	JOINER
BHS STRUT BP	BASE PLATE
BHS STRUT A	ANGLE BRT
BHS STRUT AB	BRACED BRT

SPRING STRUT NUTS

CODE	DESCRIPTION
BHS SN 10S	M10
BHS SN 10L	M10
BHS SN 12S	M12
BHS SN 12L	M12
BHS SN 10	M10 no spring

Short spring suits BHS Strut 20
Long spring suits BHS Strut 40

SLICK NUT

CODE	SIZE
BHS SLN	M10

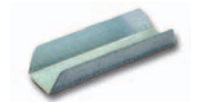

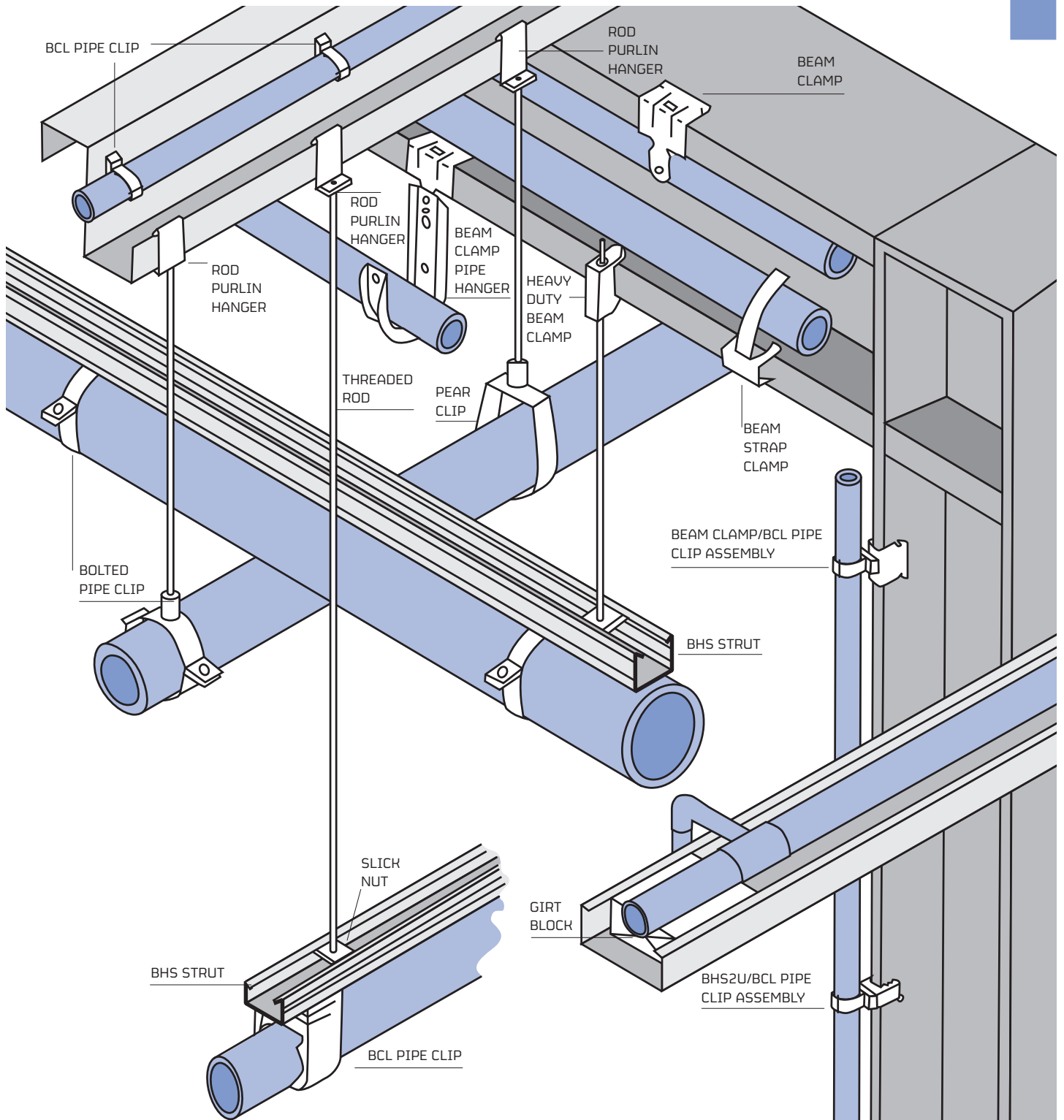

CONTINUOUS SUPPORT CHANNEL

Increases spacing between clips.

CODE	SIZE	LENGTH
BHSS20	20	3m
BHSS25	25	3m
BHSS32	32	3m
BHSS40	40	3m
BHSS50	50	3m
BHSS63	63	3m
BHSS90	90	3m
BHSS110	110	3m



Blutube

Polyurethane Hose, Reels, Coils & Tube

POLYURETHANE COILS & TUBE

- Excellent flexibility even at low temperatures
- Lightweight
- Oil & abrasion resistant
- Coils have excellent 'memory' & store neatly
- Small coil diameter stops tangling
- Straight end sections

POLYURETHANE TUBING

Superior flexibility with excellent abrasion resistance

CODE	SIZE
BTE04	4mm
BTE06	6mm
BTE08	8mm
BTE10	10mm
BTE12	12mm
BTE16	16mm

POLYURETHANE COILS

SIZES:

OD	ID
8	5
10	6.5
12	8
16	11

Standard lengths:

2m, 4m, 6m, 8m, 10m, 12m

MULTI-BORE POLYURETHANE TUBING IN STRAIGHT AND SPIRAL

High-Tech Bonded Tubing. Available in many configurations. Depending on tube sizing more than 10 tubes can be bonded. Include your electrical requirements.

BRAIDED POLYURETHANE STRAIGHT HOSE

CODE	OD	ID
BEBH-6.5 x 10	10	6.5
BEBH-8 x 12	12	8
BEBH-11 x 16	16	11

ANTI-SPATTER POLYURETHANE HOSE

Three ranges of anti-spatter polyurethane hose & tube are available for welding applications. Various sizes to suit most requirements.

SOFT-PUR BRAIDED STRAIGHT HOSE

Extra flexible

CODE	OD	ID
BSH-6.5	10.5	6.5
BSH-8	12.5	8
BSH-11	16	11

Polyethylene, Nylon, Teflon, and other specialist tubing also available

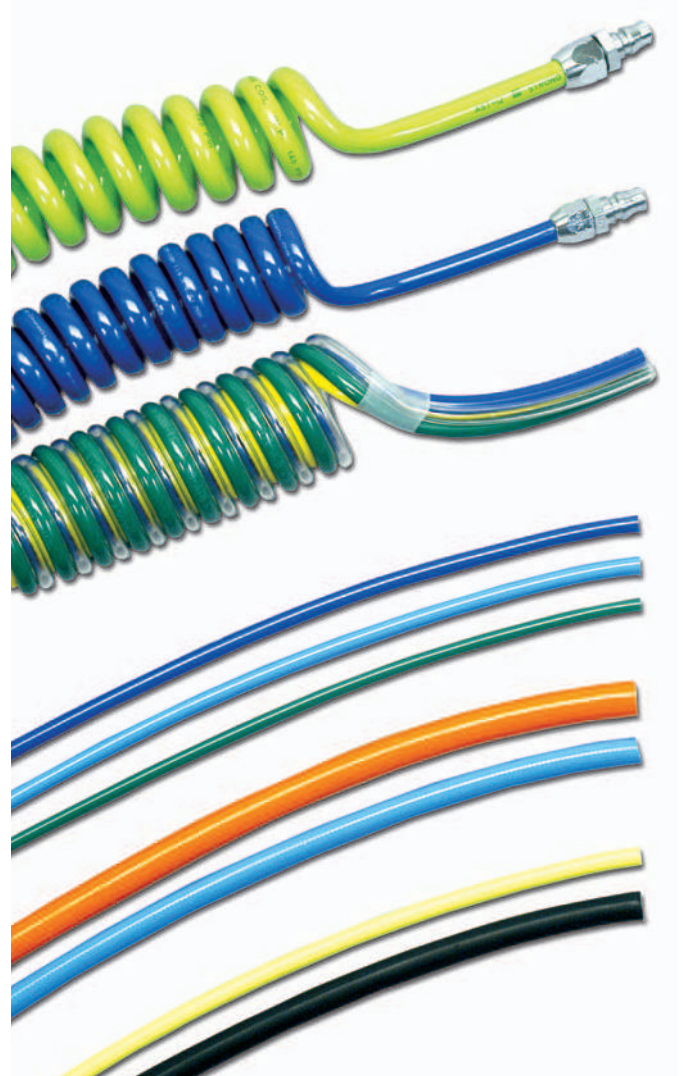

HOSE CLAMPS

- Bolted Clamp
- Stainless steel
- Worm Drive
- 2-Ear Clamps



AIR HOSE

Quality PVC Air Hose.

Bore Sizes 10mm, 12mm, 20mm, etc. (Available up to 100mm)

Length, 20, 30, 100 metres, etc.



HOSE REELS

A wide range of Hose Reels available including

- Compact Units
- Polyurethane Hose Reels
- Reels to suit Air Hose (as pictured)
- Reels for other applications





Blutube Accessories

FASTENERS

SCREWS BUTTON HEAD

CODE	SIZE
BF1	8G x 25
BF2	8G x 32
BF3	12G x 40

SCREWS HEX HEAD

CODE	SIZE
BF5	12G x 45 TYPE17 TIMBER
BF6	12G x 45 STEEL
BF7	12G x 75 STEEL
BF8*	12G x 32
BF9*	12G x 50

*LONG DRILL POINT FOR HEAVY STEEL

NYLON ANCHORS

CODE	SIZE
BF13	6.5 x 40
BF14	6.5 x 50
BF15	6.5 x 75

REMOVABLE HEAVY DUTY

CODE	SIZE
BF17	5.0 x 50
BF18	6.0 x 50
BF19	6.0 x 70

DYNA BOLTS

CODE	SIZE
BF23	6.5 x 40
BF24	10 x 50
BF25	10 x 60
BF26	12 x 60
BF27	16 x 65

DROP IN ANCHOR

CODE	SIZE
BF28	10mm
BF29	12mm

PLASTER- MATE

CODE
BF30

NYLON CABLE TIES

CODE	SIZE
BCT1	190 x 4.8
BCT2	300 x 4.8
BCT3	370 x 4.8
BCT4	380 x 7.6



ACCESSORIES

MOUNTING BRACKETS

CODE	THREAD
BTFWM15	1/2"
BTFWM20	3/4"

Designed to rigidly mount BTF or BEF fittings suits 20, 25, & 32mm Pipe fittings.



Typical use

TEFLON TAPE

CODE
BTS 1

Thread Sealing.
Only PTFE (Teflon) tape is recommended for all fittings with plastic threads.

CEILING PENETRATION

CODE	SIZE
BCPF14	14mm
BCPF19	19mm
BCPF25	25mm
BCPF32	32mm
BCPF38	38mm
BCPF48	48mm

Suitable for Suspended & Plaster ceilings.



SILICONE LUBRICANT

CODE	DESCRIPTION
BSL	500ml AEROSOL

Compression fitting
Lubricating spray.

Note: Do not use in spray painting applications. See installation instructions Page 23.



ANTI VIBRATION PADS

BAVR-S
BAVR-S Anti-vibration General Purpose.

Isolation Pads for noise and vibration isolation. Spring mounts also available for specific applications.

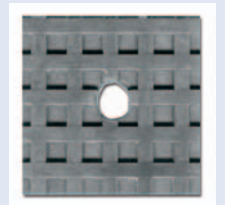

SIGNS

Refer to technical department for complete sign range.



Blutube Compressed Air Treatment

Air compressors compress air drawn from the immediate atmosphere which contains dirt, dust, moisture & other impurities, once combined with the heat & oil involved in compression the resultant mixture needs

to be removed from the air supply so tools, pneumatics, air operated machinery, etc are not damaged. In some industries (for example Food Industry) Oil Free Compressors are used so there can be no trace of oil

in the system however other impurities are still present and need to be removed. Air filters and dryers, correctly specified and maintained for your requirements, will provide suitable protection. Please refer

to the technical department. Blutube maintains the quality of treated compressed air throughout the entire pipe system unlike some traditional piping which allows rust & scale to enter the air supply.



PRE-FILTERS, FINAL-FILTERS AND ACTIVATED CARBON FILTERS

(BREATHING AIR)

Large range of multi-layer coalescing filters to remove particles, oil & water mists available.

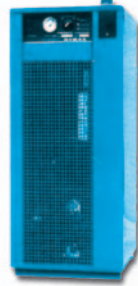

REFRIGERATED DRYERS

Refrigerated Dryers remove condensate by cooling compressed air to approx. 3° pressure dew point. Must be sized correctly for Australian conditions.



DESICCANT DRYERS

Twin tower Desiccant Dryers remove condensate and provide very low pressure dew-points. They are often used in specialist or medical applications. Single tower Desiccant Dryers are suitable for general applications. For Desiccant Dryers please refer to Technical Department.



OIL / WATER SEPARATORS

Treatment of condensate to meet legal discharge requirements.



FILTER REGULATOR / REGULATOR



FILTER REGULATOR LUBRICATOR

Full range of Regulators, Filter Regulators and FRL's available with optional automatic drains.



AUTOMATIC DRAINS

Automatic Condensate Drains available including bottom entry type.



NIL AIR LOSS AUTOMATIC DRAINS

Electronic sensor drains. 240V.

Blutube Blow Guns

Standard Blow Guns, Long Nozzle, Safety Tip, Rubber Tip, Flat Nozzle, Blow / Vacuum Venturi Effect, Reduced Pressure Safety Styles.



Blutube Couplings

COUPLING	FLOW RATE @ 90 PSI	MALE BSP			FEMALE BSP			HOSE TAILS TO SUIT HOSE			POLYURETHANE HOSE				ONE TOUCH CONNECT	FEATURES
		1/4"	3/8"	1/2"	1/4"	3/8"	1/2"	8mm	10mm	12mm	5 x 8	6.5 x 10	8 x 12	11 x 16		
A CEJN 315	70 CFM	✓	✓	✓	✓	✓	✓	✓	✓	✓	✓	✓	✓	✓	✓	Safety Purge Plugs also available
B CEJN 320	85 CFM	✓	✓	✓	✓	✓	✓	✓	✓	✓	✓	✓	✓	✓	✓	Safety Purge Plugs also available
C CEJN 342 BREATHING AIR	69 CFM	✓	✓	✓	✓	✓	✓	✓	✓	x	x	x	x	✓	✓	Safety twin touch disconnection for breathing air
D HI-CUPLA ACE PLASTIC	70 CFM	✓	✓	x	x	x	x	✓	✓	x	✓	✓	✓	✓	✓	Button lock, light weight
E JAMEC 310	28 CFM	✓	✓	✓	✓	✓	✓	x	✓	✓	x	x	x	✓	✓	
F JOPLA PLASTIC	72 CFM	✓	✓	✓	✓	x	x	✓	✓	✓	✓	✓	✓	✓	✓	Safety twin touch disconnection for breathing air
G NITTO HI-CUPLA 200	82 CFM	✓	✓	✓	✓	✓	✓	✓	✓	✓	✓	✓	✓	✓	✓	Locking models available
H OETIKER SWING SAFETY	103 CFM	✓	✓	✓	✓	✓	✓	x	✓	✓	x	✓	✓	✓	✓	Built in lock and safety purge, full bore flow

✓ = Available x = Not Available

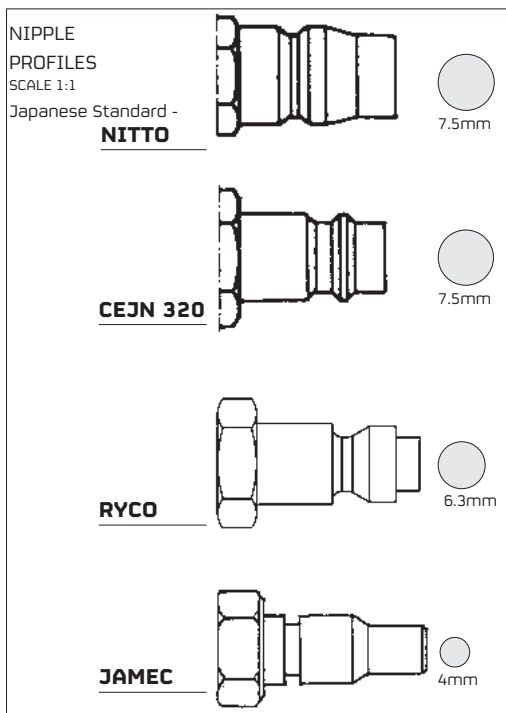

NITTO TWIST PLUG

Twisting, kinking and bending of hoses are prevented. Various models available.



HOSE TAIL COUPLING

CODE	TO SUIT HOSE
BCCHT20	3/4" (20mm)
BCCHT25	1" (25mm)

MALE CLAW COUPLING

CODE	TO SUIT THREAD
BCCMT20	3/4" (20mm)
BCCMT25	1" (25mm)

FREE-ANGLE FITTING

Unique design 360° rotation fitting. Various models available.



FEMALE CLAW COUPLING

CODE	TO SUIT THREAD
BCCFT20	3/4" (20mm)
BCCFT25	1" (25mm)



Blutube Design

BLUTUBE OPERATING PRESSURE / TEMPERATURES

OPERATING TEMP °C	DESIGN LIFE YEARS	PERMISSIBLE WORKING PRESSURE		
		BAR	KPA	PSI
- 20° TO 20°	50	16	1600	235
30°	50	14.1	1410	205
40°	50	12	1200	175
50°	50	10.2	1020	150
60°	50	8.8	880	130
ABOVE RATINGS HAVE AN ADDITIONAL SAFETY FACTOR OF 2:1				
Fluid at 20° C	50	25	2500	360

SHORT TERM TEMPERATURE PEAKS

Temperatures quoted relate to constant temperature over a period of 50 years, rather than short term peak temperatures. Blutube can safely handle short term peaks in compressed air

temperature up to 95deg C. Circumstances vary and each high temperature application should be checked by the technical department.

SAFETY FACTOR

At all rated pressures for compressed air as above Blutube

is manufactured with a safety factor of 2. On a typical installation this gives an effective safety factor of 4 at 800 kpa/20deg C /50 years.

GUARANTEE

Blutube is manufactured to AS 4130/AS 4131 and is accordingly

guaranteed for 50 years provided recommended design, installation and operating practices are adopted. As established from long term testing, Blutube may be operated continuously under pressure for up to 200 years at 20deg C.

CONDENSATE DRAINAGE

Condensate should be removed as soon as possible in a pipe system. A suitably sized compressed air dryer after the Air Receiver is a recommended method for removing condensate from the air supply. If a high short term requirement of dry air is required, then the dryer would be better installed prior to the Receiver. The good thermal characteristics of Blutube are a further advantage.

The system should be designed to minimise or eliminate harmful condensate from being discharged into air tools and equipment when dryers are not fitted. The recommended method is to install the dropper from the bottom of the branch or mainline with a short extra length of pipe extending below the outlet to form a water trap, this then terminating with a drain valve for

the removal of condensate.

Horizontal pipe can be sloped at a slight gradient to strategically positioned drainlegs, outlet droppers can come off the top of the pipework to avoid precipitated condensate being discharged in the airstream.

UNDERGROUND PIPEWORK

Blutube is ideal for underground installation with its high strength characteristics and ability to absorb ground movement. It is recommended to lay pipework in sand, grade and install drain valves in strategic positions. Please refer to Technical Department for details.

HAZARDOUS AREAS

Corrosive chemicals

Blutube has excellent resistance to a broad range of chemicals and is ideal for use in many areas where corrosive liquids

or atmosphere may contact the pipe. Compression fittings come standard in polypropylene construction with O-Rings of nitrile rubber and Split Grip Rings in Polyacetal. The Nitrile gives excellent resistance to oils in the compressed air. For aggressive chemical applications CPVC Split Rings and O-Rings in EPDM or Viton are available. Fusion welded fittings provide a further degree of safety in these areas. User should verify compatibility of components with their application. Extensive compatibility charts are available. Resistance to specific chemicals should be checked with Technical Department.

Explosive or ignitable atmosphere

Compressed air can carry static charges which may accumulate. The user/customer/purchaser is responsible to identify any potential hazardous areas and

to take necessary measures or precautions for complete safety. Information on protective measures is available with advice on your specific application.

HEAT SOURCES AND EXTERIOR PIPEWORK

Blutube is suitable for outdoor installation. Industry best practice of shielding equipment and pipework from direct heat sources should be adopted to prevent excessive heat buildup. In the event that pipe is exposed to direct sunlight a surface layer forms over time creating a barrier which impedes further U.V. effects. As with all Polymer pipe systems exposed to direct U.V., there may be some reduction of impact resistance over time however longevity and pressure rating of Blutube is not affected.

SOCKET FUSION WELDED FITTINGS

Pipe and fittings are welded by socket fusion method to AS2033-1980. Fittings comply with DIN16963. The fittings are heated simultaneously with pipe then joined to give an extremely strong weld of high pressure capability, fusing pipe and fitting into one integral piece. Made in Europe specially for compressed air pipe systems.

ELECTRO FUSION WELDED FITTINGS

Fittings for electro fusion comply with AS4129 and carry a standards mark licence under a Quality Assurance System in accordance with ISO 9002. The fittings incorporate a resistor in one of the terminals which is specific to that fitting. The automatic control box reads the resistor and sets and welds the correct time, avoiding operator error. Fittings are also labelled for barcode reading and manual

setting times. Rising melt indicators confirm successful completion of weld.

COMPRESSION O-RING TYPE FITTINGS

Compression fittings manufactured under ISO 9002 Quality System and have Standards Mark Licence No 2018-AS4129. Air seal is provided by a heavy duty O-Ring and pipe is securely held by split grip ring and nut. Extensive research and experience has confirmed our

confidence in the range of fittings offered being of the highest quality and reliability. These fittings are approved by the manufacturer for compressed air applications and, whilst they are conservatively rated at PN16 (16 bar)/20degC/50 years for other applications, with a view to an additional safety factor for compressed air, we recommend these fittings for installations subject to conditions not exceeding 10 bar pressure at constant average temperature of 40degC.

Blutube Fittings

A complete range of Push-in Fittings are available to suit flexible tubing from 4mm to 16mm.



Blutube Installation

THERMAL EXPANSION AND CONTRACTION PIPE CLIPS / PIPING LAYOUT

Blutube thermal expansion and contraction is 0.18mm per metre per Deg C. If pipework is to be subjected to thermal temperature change, expansion and contraction

needs to be allowed for while system is being installed. Movement can be absorbed on changes of direction, elbows, etc. but on longer lengths the recommended installation principles as set out below should be adhered to. This movement is minimised if areas in which pipework is

installed are heated or cooled and eliminated in constant temperature areas.

EXPANSION LOOPS

Install expansion loops at intervals of approx. 30-40m on long runs. For leg lengths refer to table below. It is general practice for loops up to

BLUTUBE63 to span between purlins.

PRESTRESSING

Pipework can be prestressed, and particular note should be made of this when installation is carried out in cold conditions.

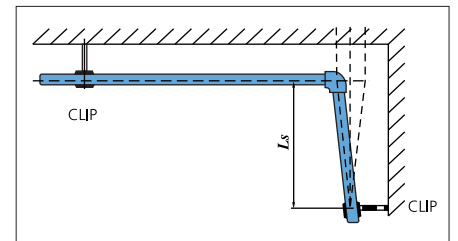
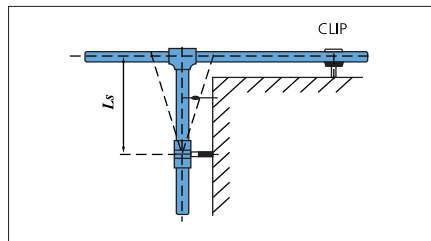
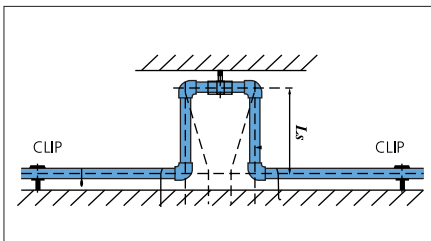

Suggested L s Length (Metres)

20	0.5
25	0.6
32	0.7
40	0.9
50	1.0
63	1.2
90	1.8
110	2.0
160	2.4

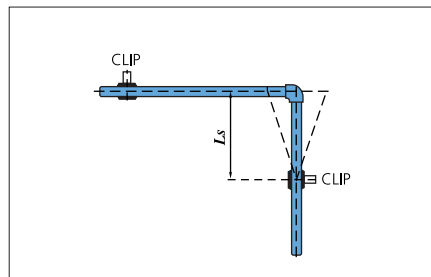

PIPE CLIPS

Free axial movement of pipework should be allowed with any form of support. Pipework should be able to move on elbows, tees, etc.

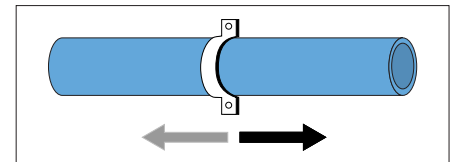

ANCHOR POINTS

Anchor points are clips which don't allow free axial movement. Anchor points can be used as shown to evenly spread the effects of expansion and contraction.

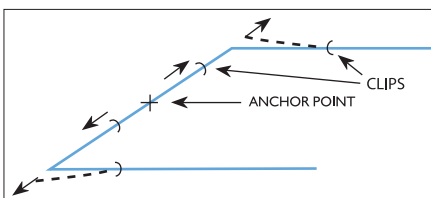

Below: Working example of Ring Main showing typical expansion loops and anchor point positions for this schematic.

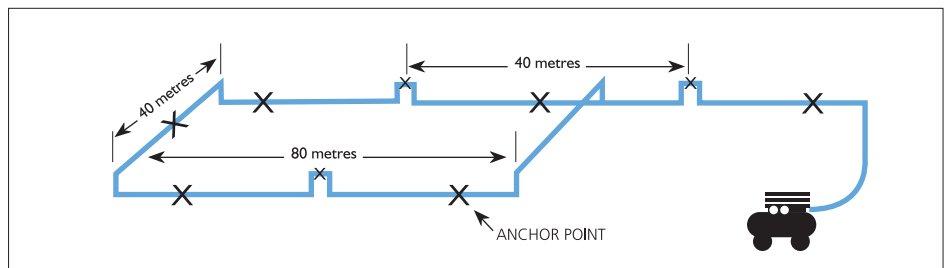

Blutube Socket & Electro Fusion Welding Instructions

PROCEDURE:

1. INSTALL CLIPS & PIPE SUPPORT SYSTEM.

2. FOR SOCKET FUSION PRE-MANUFACTURE MAIN LINES ON GROUND.

Electro Fusion Welding – Recommended for BLUTUBE90 to BLUTUBE160



1. Cut pipe to length using appropriate cutters.
2. Use scraper BWPS 16063 to remove oxide layer from pipe for full fitting insertion length to approximate depth of 0.3mm.



3. Wipe surfaces to be welded with Welding Wipes (BEFPW) to remove dust etc, and allow cleaner to evaporate.



4. Assemble pipe and fitting making sure pipe is FULLY inserted. Clamps may be attached to stabilise joint during welding.



5. Connect welder leads onto fitting terminals. Set correct weld time (marked on each fitting). Follow instructions for particular welder. Press start for weld cycle to commence. Allow to cool, time is marked on each fitting.

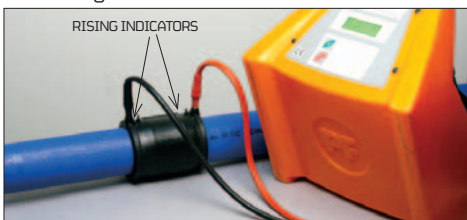

6. Rising melt indicators confirm successful completion of weld. When weld cycle is completed, allow assembly to cool without any movement or strain.

SOCKET FUSION

Heating element socket fusion to welding guideline AS 2033-1980. Weld surfaces must be clean and dry. Welding machine must be up to temperature 230° - 250° C before commencing. Avoid cold windy conditions. Do not realign joint after adjusting time, see table below. Do not overscrape pipe - interference fit must be retained.

Do not twist pipe into fitting when fusing.

Socket Fusion Welding Time/Temperature Chart

Pipe OD mm	Pre-Heating Sec.	Adjusting Sec.	Cooling Min
20	5	4	2
25	7	4	2
32	8	6	4
40	12	6	4
50	18	6	4
63	24	8	6
90	40	8	6
110	50	10	8

ELECTRO FUSION

Fittings for electro fusion comply with AS4129. Automatic control box reads resistor and sets and welds the correct time, fittings also labelled for manual setting times. Weld surfaces must be clean and dry.

Do not overscrape pipe. Use correct scrapers.

Do not use emery paper or metal files.

IMPORTANT: Do not allow movement in the joint until cooling period has been completed. In some cases clamps may be required. Ensure continuous electricity supply during weld cycle.

Socket fusion Welding Instructions BLUTUBE20 to BLUTUBE63

Use Socket Fusion Bench Machine for up to BLUTUBE90.



1. Turn on Welder BSFHM. Do not attempt welding unless tool is up to temperature (250°C). The light will flash on/off with thermostat control when temp. is correct.
2. Cut pipe to length required with (BPC...) cutters for a swarf free finish.



3. Clean pipe & fitting. Use scraper (BWPS...) to remove oxide layer from pipe and ensure correct tolerance. Welding wipes (BEFPW) may be used if required.



4. Simultaneously insert pipe and fitting onto socket and spigot to full depth without twisting. Hold for correct time as per table 'Pre-heating seconds' (left)

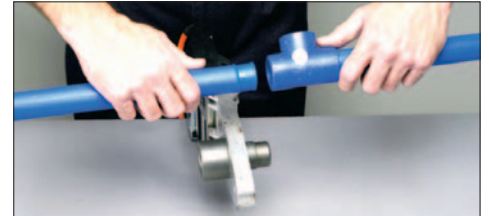

5. Remove pipe & fitting from heating element, immediately insert pipe into fitting without twisting.



6. Check alignment within 'adjusting seconds' as per table (left).

During cooling avoid mechanical strain or movement on welded joint.



Blutube Installation Instructions

PROCEDURE:

- 3. INSTALL PIPE WORK INTO CLIPS. 4. INSTALL BRANCHES & OUTLETS. 5. TEST AND COMMISSION PIPE SYSTEM.**

Compression Fittings BLUTUBE20 to BLUTUBE63



1. Cut pipe to length with appropriate cutter (BPC...) for a swarf-free finish.



2. Chamfer with appropriate chamfering tool. (BCHAM...) This may not be necessary for BLUTUBE20, 25, 32.



3. Remove nut and conical grip ring from fitting and mount on pipe in the same order with the large end of the grip ring facing fitting. Lubricate, see notes*, **.



4. Insert the pipe into fitting with a twisting motion until it passes through the "O" ring and meets the internal shoulder. Ensure that grip ring is touching the fitting.



5. Screw and tighten the nut onto the fitting firmly by hand. The larger pipe sizes 40mm & upward will need tightening with the appropriate wrench (BNW1) however, do not use excessive torque.

** Lubricate with silicone spray, soapy water or vaseline except on specialist applications. ie: powder coating, spray painting, breathing & quality air, etc. DO NOT use penetrating fluids such as WD40, 5-56, Penetrene etc.

Compression Fittings BLUTUBE90 to BLUTUBE110



1. Cut pipe to length and chamfer.
2. Remove nut, conical grip ring, bushing and "O" ring and mount on pipe in the same order leaving out grip ring.
3. Lubricate pipe end and inside of fitting. (See note below**)



4. Insert pipe into the fitting until it meets the internal shoulder.



5. Bring up the "O" ring and bushing and tighten nut until they are fully in place.



6. Unscrew nut, open grip ring and put on pipe with the large end touching the bushing.



7. Tighten nut with the appropriate wrench (BNW2) taking care not to use excessive force.

*Fitting may be supplied with a tapered seal instead of O-Ring, -in this case nut need not be removed, - simply chamfer pipe, lubricate, fully insert, and tighten.

BCL Pipe Clips Installation



1. Mount pipe clip using appropriate fastener. In vertical mounting situations (horizontal pipe-work) ensure female ratchet is uppermost as shown below.

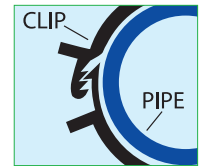

2. Pull clip apart and put the pipe in.



3. Press the pipe into clip towards the clip base and set to appropriate setting.



To remove pipe from clip push the 2 bands sideways in opposite directions to disengage.

Pipe Support Spacings

HORIZONTAL SUPPORT SPACING

PIPE SIZE	UP TO 25° C	UP TO 50° C
BLUTUBE20	700	600
BLUTUBE25	900	750
BLUTUBE32	1200	900
BLUTUBE40	1400	1100
BLUTUBE50	1600	1200
BLUTUBE63	1800	1400
BLUTUBE90	2000	1600
BLUTUBE110	2400	1800
BLUTUBE160	2700	2100

Spacings may need to be altered for various ambient temperatures encountered. Spacings may also be increased using Continuous Support Channel, see P15. Spacings will need to be decreased if pipework is conveying fluids. Refer to Technical Department.

Compressed Air Flow Chart

FOR USE WITH LARGE INSTALLATIONS OR LONG DISTANCE OF PIPE

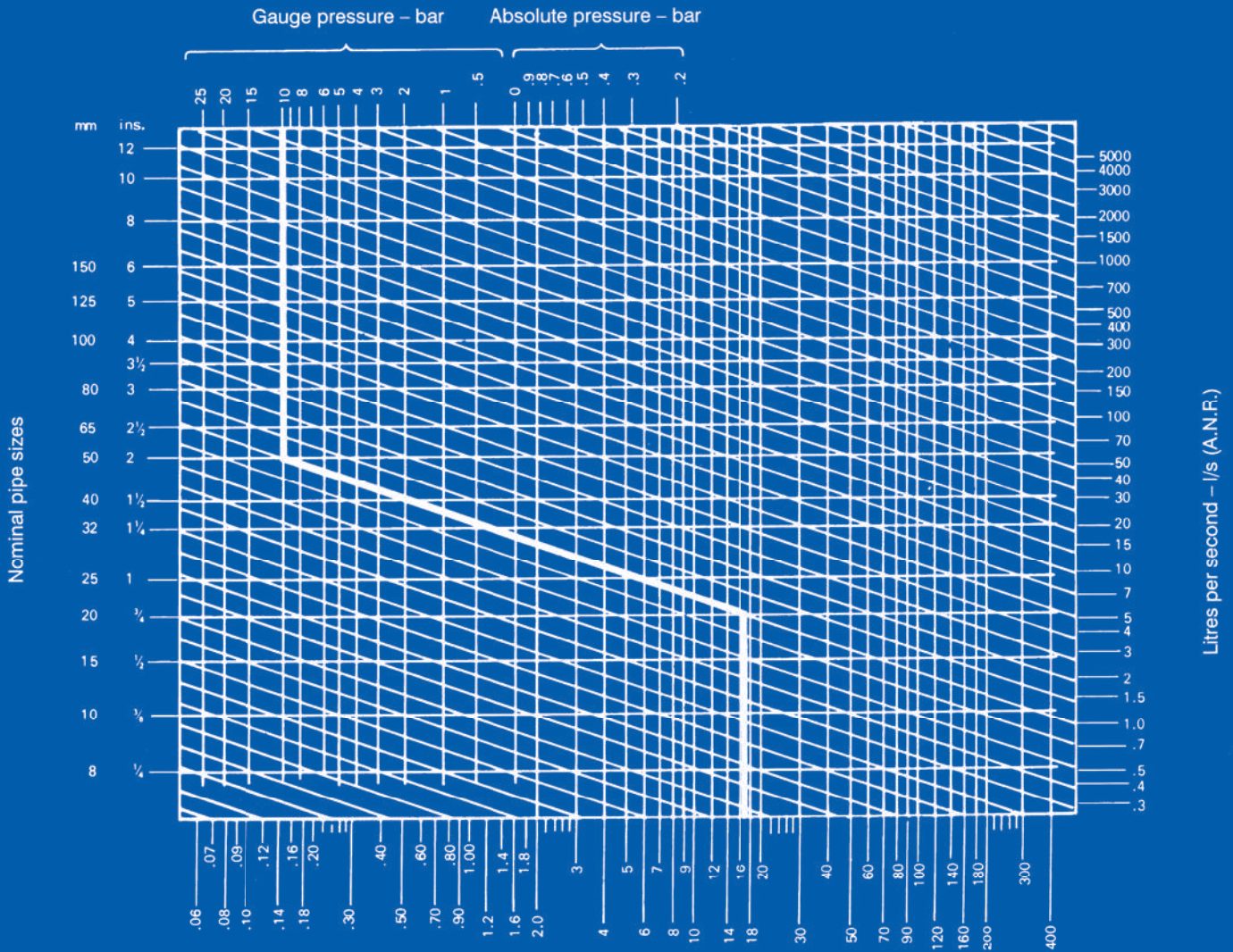

Pressure drop - mbar per metre

Note: A.N.R (Atmosphere Normale de Reference) Standard Reference Atmosphere ISO R554 - 20degC 65% Relative Humidity 1013 mbar

Conversion: 1mbar=0.1kpa
1l/s=2.1191cfm

How to use the compressed air flow chart.

Four quantities are involved in the use of this chart, these being air pressure, rate of flow, pipe size and pressure drop. Any one of these can be determined providing the remaining three are known.

Problem 1:

Air initially at 10 bar is being transmitted at a rate of 60 l/s free air through 20mm pipe. What will be the pressure drop due to friction through 30 metres of pipe?

Solution:

(This example is plotted on the chart) From the point representing 10 bar at the top of the chart proceed down vertically to intersect with the horizontal line representing 60 l/s on the right hand scale. Proceed diagonally downwards, parallel to the guide lines to intersect the horizontal line representing 20mm on the left hand side scale. From this point proceed vertically to the pressure drop scale on the bottom of the chart and take the reading. The pressure drop is found to

be approximately 17 mbar per metre of pipe or 510 mbar (0.5 bar) per 30 metres of pipe.

Problem 2:

10 l/s of free air is required at a pressure of 4 bar with a maximum allowable pressure drop of 140 mbar per 30 metres of pipe. What would be the recommended pipe size for this application?

Solution:

From the point representing 4 bar on the top axis of the chart proceed down vertically to intersect the horizontal

line representing 10 l/s on the right hand scale. Proceed diagonally, parallel to the guide lines to intersect the vertical line from the bottom scale representing the allowable pressure drop of 140 mbar per 30 metres of pipe (Read $140/30 = 4.5$). From this intersection point proceed horizontally to the left hand side of the chart. The point falls between 10mm and 15mm pipe sizes. The correct selection therefore, is 15mm pipe.



Blutube Technical Specifications

The Compressed Air System shall be Blutube, non-metallic, blue in colour, corrosion free, conforming to AS/NZS 4130/4131 and be made to PN 25 under an accredited AS 3902 Quality Control System.

Pipe

The pipe shall be PN 25 with a safety factor of 2:1; rated at 16 Bar / 20degC / 50 year de-

sign life and 8.8 Bar / 60degC / 50 year.

Fittings

All fittings shall be Blutube Socket Fusion, Electro Fusion or Compression style fittings which comply with Australian Standards as listed below. Blutube Socket Fusion fittings shall be made to DIN 16963 which shall be welded to AS

2033. Blutube Compression fittings shall be either 'O' Ring or tapered seal to comply with AS/NZS 4129 and carry a Standards Mark Licence No. 2018 in accordance with ISO 9002.

Blutube Electro Fusion fittings shall comply with AS/NZS 4129 and carry a Standards Mark Licence under Quality Assurance System in

accordance with ISO 9002. Fixing of pipe shall be of a type and spacing approved for use as per Blutube Technical Manual.

Breathing Air

Breathing Air and Medical applications

Blutube is suitable for breathing air and medical applications, Technical Department recommendations must be adopted. It is the user's responsibility to provide and maintain supply air at a suitable level of purity for these applications.

Storage

Storage and transport

Pipe should be stored and transported straight and true.

Shipping Weights

Blutube20 0.9 Kg / 6m length
Blutube25 1.4 Kg / 6m length
Blutube32 2.4 Kg / 6m length
Blutube40 3.5 Kg / 6m length
Blutube50 5.5 Kg / 6m length
Blutube63 8.7 Kg / 6m length
Blutube90 18 Kg / 6m length

Blutube110 27 Kg / 6m length

Blutube160 55 kg / 6m length

Other uses

Blutube as detailed in this technical manual is also suitable for:

- High pressure Fluid to 25 bar
- Chilled Water
- Warm Water
- Inert Gasses
- Chemical Piping
- Vacuum Piping

Please refer to Technical Department for details.

Trading Terms

As part of a process of continual improvement, the Company reserves the right to upgrade or modify components from the description in this manual at any time without notice. Whilst due care and revision has been taken in preparation of this Manual, the Company

takes no liability for accuracy of information contained herein.

No part may be reproduced in any way without written permission from the Company. All Sales are subject to the Company's Terms and Conditions of Sale. E & OE.



Ibex Australia

T 1300 85 45 20

T +61 3 9338 6111

E sales@ibexaustralia.com.au

ibexaustralia.com.au